

# Selector Guide

<b>Introduction</b>	<b>Introduction</b> . . . . .	<b>2-3</b>	
	<b>Solid State Relays</b>	<b>Panel Mount</b> . . . . .	<b>4-5</b>
		<ul style="list-style-type: none"><li>• SV Series - 10 thru 75 Amp, 330 Vac &amp; 660 Vac Output</li><li>• SVDD Series - 12 thru 40 Amp, 100 Vdc Output</li></ul>	
		<b>DIN Rail Mount</b> . . . . .	<b>7-12</b>
	<b>Single Phase</b>		
	<ul style="list-style-type: none"><li>• RV Series - 25 or 40 Amp, 660 Vac Output, Solid State Relay</li><li>• RS Series - 50, 75 or 100 Amp, 660 Vac Output, Solid State Relay</li><li>• RVMA Series - 25 or 40 Amp, 660 Vac Output, SCR Controller</li></ul>		
	<b>Three Phase</b>		
	<ul style="list-style-type: none"><li>• RVx3 - 25 Amp, 660 Vac Output, Solid State Relay</li><li>• RVM3 - 25 Amp, 660 Vac Output, SCR Controller</li></ul>		
	<b>SV, RV &amp; RS Accessories</b> . . . . .	<b>6, 16</b>	
	<ul style="list-style-type: none"><li>• Semiconductor Fuses &amp; Holders</li><li>• Heat Sinks</li></ul>		
<b>Input &amp; Output Modules</b>	<b>Input &amp; Output Modules</b> . . . . .	<b>13-14</b>	
	<ul style="list-style-type: none"><li>• AC or DC Input - Positive or Negative Logic</li><li>• AC or DC Output - Positive or Negative Logic</li></ul>		
	<b>I/O Accessories</b> . . . . .	<b>15</b>	
<ul style="list-style-type: none"><li>• Jumper Strips</li><li>• Marker Cards</li></ul>			
<b>Application Notes</b>	<b>Information &amp; Guidelines</b> . . . . .	<b>17-25</b>	
	<ul style="list-style-type: none"><li>• Heat Sinking</li><li>• Three Phase Relays</li><li>• General Guidelines</li></ul>		

The information in this catalog has been carefully checked and is believed to be accurate, however, no responsibility is assumed for possible inaccuracies or omissions. We constantly endeavor to enhance the quality of our products; therefore, specifications are subject to change without notice.

© Copyright 2007 Eurotherm Inc.

Document No. HA136716-CII Issue 2c



## History

Since the early 70's, Solid State Relays have been the standard in switching technology, due to their high switching frequency, resistance to shock and vibration and superior lifetime.

Continental Industries began actively pursuing market growth in 1984. The company's corporate office, research and development, and manufacturing facilities are located in multiple facilities throughout the USA, Canada and Europe.

Continental Industries is a part of Eurotherm Inc. Over 75% of the company's business is in controls and automation with products ranging from advanced computer systems for industrial plant automation, to building environmental controls and to electronic devices found in many domestic and commercial appliances.

## Benefits of Continental's Solid State Relays

### Long Life Reliability

When properly used, a Solid State Relay (SSR) provides a high degree of reliability, long life and reduced electromagnetic interference (EMI), together with fast response and high vibration resistance, as compared to an electromechanical relay (EMR). An SSR offers all the inherent advantages of solid state circuitry, including consistency of operation and a typically longer usable lifetime. This is possible because the SSR has no moving parts to wear out or arcing contacts to deteriorate, which are primary causes of failure of an electromechanical relay. When properly applied, an SSR will have a normal life expectancy of many millions of operations, 10–1000 times more than most electromechanical relays. SSRs also have environmental advantages compared to mercury contactors.

### Fast Switching

Solid state relays can switch up to 120 times per second, much faster than any electromechanical relay. When used in heating applications, fast cycling can dramatically improve the life of the heater by reducing thermal stress.

### Low Input Power Required

SSRs allow the switching of large loads via ultra-sensitive input power. A low level logic signal (TTL) can activate a switch for as much as 100 Amps.

### Quiet Operation

Completely quiet switching, beneficial in medical applications, environmental controls or other areas where quiet operation is desirable. Zero-crossing control also means low electrical noise when used near computers, PLC™s, SCADA systems, or other factory automation control systems.

## Relay Packaging

Continental Industries is an industry leader in product innovation. We were the first company in the U.S. to produce and market a fully integrated DIN Rail mountable solid state relay with heat sink. We have proven that leadership again with the introduction of the SV family of SSRs that include the Superior Surge Survival™ technology.

## Applications for Relays

Solid State Relays are typically used to operate devices such as motors, heaters and lights from low-power signals such as those generated by computers, microprocessors and other logic systems. Here are some examples:

Heating Controls	Amusement Park Rides	Motor Controls
P.C. Drilling Machines	X-Ray Developers	Mercury Relay Replacements
Industrial Process Controls	Commercial Cooking Appliances	Centrifuges
Electrostatic Precipitators	Electromechanical Replacements	PCB Lamination Presses
Electromagnets	Life Test Equipment	Lubrication Systems
Induction Furnaces	Welding Controls	Pizza Ovens
Solenoid / Valve Drivers	Artificial Vision Systems	Battery Chargers
Solar Tracking Systems	Blood Sample Analyzers	Industrial Fans & Blowers
Chemical Processing Equipment	Laundry Equipment	Wind Power Systems
Studio & Theatrical Lighting	Control Systems	Test Systems
High Speed Line Printers	Plastic Molding & Extrusion	Servo Systems
(Heated) Ultrasonic Cleaners	Fire and Alarm Systems	Navigation Equipment
Trains & Subways (Door Controls)	Traffic Controls	Utility Control Systems
Maximum Security Systems (Prison Doors)	Production Equipment	Lighting Displays
Assembly Equipment	Computer Hard Disk Drives	Automatic Dispensing Machines
Copy Machines (Xerography)	Vending Machines	ATM Machines
Semiconductor Wafer Fab Equipment	Machine Tools	Egg Incubators
Plastic Thermoforming	Aircraft Ground Support Equipment	Industrial Furnaces

## Benefits of Continental Industries SSR Products

- High performance
- Direct bonded copper technology
- 100% Tested
- Zero-crossing
- Output voltages to 660 Vac
- AC or DC control signals
- 4-20mA analog input signals
- AC or DC output relays
- Compact and innovative designs
- Available from factory stock and local distributors
- UL/CSA/CE





# SV Series - Panel Mount Solid State Relays

## FEATURES/BENEFITS

- 10 - 75 amps, 330Vac max.
- 50 - 75 amps, 660Vac max.
- Single phase, zero crossing
- LED input indicator
- Clear safety cover included
- Panel mount
- DC and AC input versions
- Superior surge survival
- Meets EN60947-4-3
- UL recognized, CSA listed, CE approved
- 100% tested

## SPECIFICATIONS

**Dimensions inches (mm):** 2.25(57.1)H x 1.75(44.5)W x 1.37(34.8)D on vertical panel

**Load type:** Resistive

### Inputs:

#### SVDA-DC Input

DC Logic: 10-25A ON  $\geq$  4Vdc/5.4mA, 32Vdc/10mA max., current limited  
 50-75A ON  $\geq$  4Vdc/3.5mA, 32Vdc/8mA max., current limited  
 OFF  $\leq$  1Vdc

#### SVAA-AC Input

AC Logic: ON  $\geq$  100V, 280Vac max.  
 OFF  $\leq$  2mA, 10k $\Omega$  impedance

#### Current ratings:

10A, 25A, 50A and 75A

#### Voltage ratings:

3Vxx rating option: 24V to 330V max.  
 6Vxx rating option: 24V to 660V max.

**Operating temperature:** 0°C to 40°C (up to 80°C with derating)

**I<sup>2</sup>t (A<sup>2</sup>/secs):** 10A-60, 25A-260, 50A-1620, 75A-7010

**Peak blocking voltage:** 800V, impulse (300Vac), 1200V, impulse (600Vac)

**Offstate dVdT:** **300V 600V**  
 10A-750V/ $\mu$ sec 50A-500V/ $\mu$ sec  
 25A-750V/ $\mu$ sec 75A-500V/ $\mu$ sec  
 50A-1000V/ $\mu$ sec  
 75A-1000V/ $\mu$ sec

## SCHEMATICS/DIMENSIONS

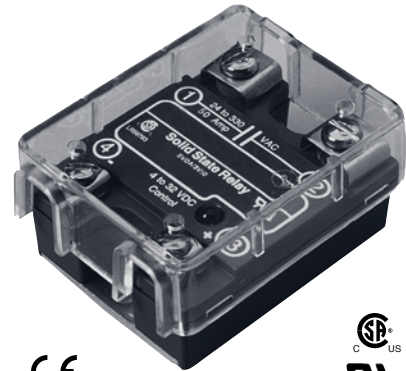
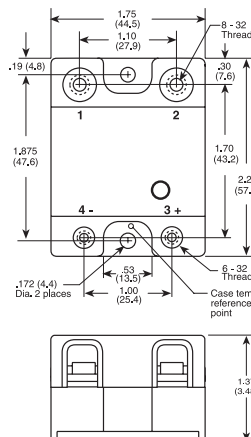
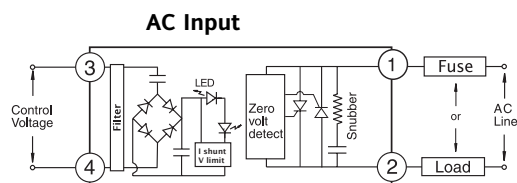
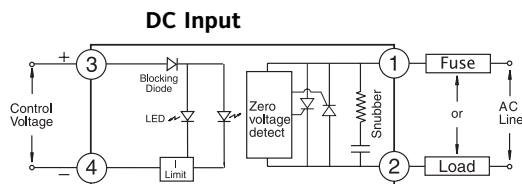

See pages 6 and 17-19 for heat sinking considerations and thermal transfer pads. See page 16 for fuse selector chart.

## ORDERING CODES



Model	Rating
SVDA 4-32Vdc input, AC output	3V10 10 amps, 300 volts 3V25 25 amps, 300 volts
SVAA 100-280Vac input, AC output	3V50 50 amps, 300 volts 3V75 75 amps, 300 volts 6V50 50 amps, 600 volts 6V75 75 amps, 600 volts

### Heat sinks and Accessories (mm)

S505-heatsk-1.5	76.2 H x 111.8 W x 66.8 D
S505-heatsk-1.0	139.7 H x 111.8 W x 66.8 D
Heatsk-DIN-1.6	80 H x 60 W x 71.1 D
Heatsk-DIN-1.0	116.59 H x 60 W x 86.3 D
Heatsk-6pk-1.2	579 H x 60 W x 71.1 D
Cover Safety-000	Clear Cover
Thermal-pad-005	5 pack of thermal pads
Thermal-pad-025	25 pack of thermal pads

**NOTE:** Adequate heat sinking, including consideration of air temperature and flow, is essential to the proper operation of a solid state relay. Units should not be mounted in an enclosed area without proper air flow. Units should also never be mounted to a plastic base or to a painted surface. Failure to provide adequate heat sinking with thermal gel or pad will cause a solid state relay to fail.

See page 6 and pages 17-19 for more details.

# SVDD Series - Panel Mount DC Solid State Relays

## FEATURES/BENEFITS

- 12 to 40 amps, 100Vdc output
- DC control input
- Optically isolated
- LED input indicator
- Clear safety cover included
- 100% tested

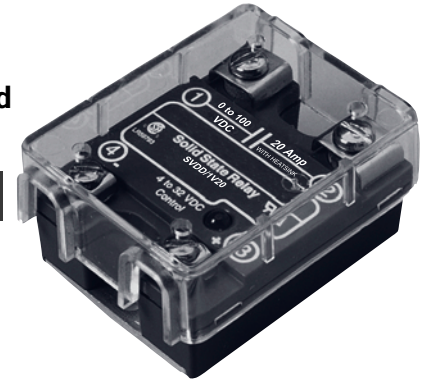

See pages 6 and 17-19 for heat sinking considerations and thermal transfer pads.

## SPECIFICATIONS

<b>Dimensions inches (mm):</b>	2.25 (57.1) H x 1.75 (44.5) W x 1.37 (34.8) D when mounted on a vertical panel.
<b>Input (Control):</b>	4-32Vdc, 6-10mA max. $\geq$ 1Vdc off
<b>Output (Amps):</b>	12A, 20A, 40A
<b>Current surge (non-repetitive):</b>	12A-30Apeak, 20A-60Apeak, 40A-120Apeak
<b>On-state resistance (at 40°C base plate temp):</b>	12A-0.1456 $\Omega$ , 20A-0.0728 $\Omega$ , 40A-0.03696 $\Omega$
<b>Thermal resistance:</b>	12A-1.8°C/W, 20A-1.0°C/W, 40A-0.55°C/W
<b>Voltage range of output:</b>	0-100Vdc
<b>Leakage:</b>	2mA
<b>Turn on/off time:</b>	25 $\mu$ sec at $\geq$ 8Vdc*
<b>High frequency switching test:</b>	100% of relays are tested at 15KHz @ 50% duty cycle @ 10V control input

\*25 $\mu$ sec turn on time applies when switching greater than 8V. Turn on times at less than 8v are slower.

## ORDERING CODES

Model	Rating

## SCHEMATIC/DIMENSIONS

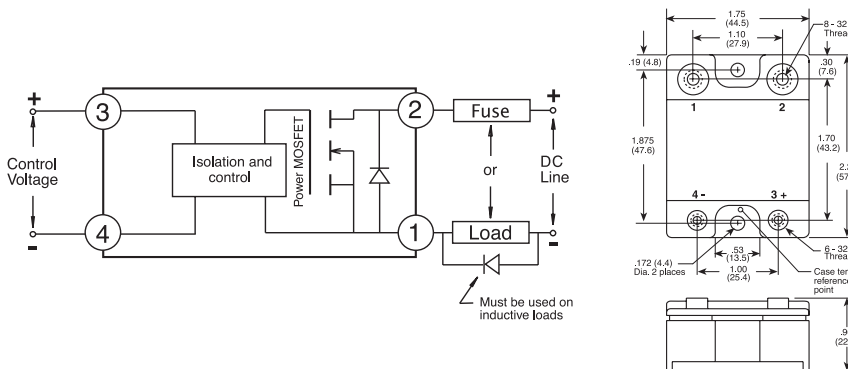

Model	Rating
SVDD	1V12 12 amps, 100Vdc 1V20 20 amps, 100Vdc 1V40 40 amps, 100Vdc

## Heat sinks and Accessories (mm)

S505-heat-sk-1.5	76.2 H x 111.8 W x 66.8 D
S505-heat-sk-1.0	139.7 H x 111.8 W x 66.8 D
Heat-sk-DIN-1.6	80 H x 60 W x 71.1 D
Heat-sk-DIN-1.0	116.59 H x 60 W x 86.3 D
Heat-sk-6pk-1.2	579 H x 60 W x 71.1 D
Cover Safety-000	Clear Cover
Thermal-pad-005	5 pack of thermal pads
Thermal-pad-025	25 pack of thermal pads

## POWER CURVES

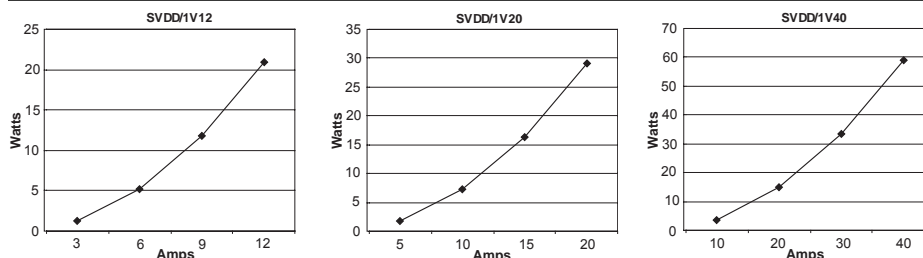

**NOTE:** Adequate heat sinking, including consideration of air temperature and flow, is essential to the proper operation of a solid state relay. Units should not be mounted in an enclosed area without proper air flow. Units should never be mounted to a plastic base or painted surface. Failure to provide adequate heat sinking with thermal gel or pad will cause unit to fail.

See page 6 and pages 17-19 for more details.



# DIN Rail Mountable Heat Sinks

## FEATURES/BENEFITS

- **DIN rail mountable**
- **Space saving design**
- **Ground screw built-in**
- **Drilled and tapped to fit panel mount relays**

See pages 17-19 for calculating your heat sink requirements

As ambient temperature increases or as amperage increases, the use of a properly sized heat sink becomes necessary. The smaller the “heat sink rating” number, the better the heat sink is at dissipating the heat. The new DIN heat sinks are the outstanding choice for most applications because: 1) they use the least amount of sub-plate mounting space, 2) they extend the heat sink forward for the best air flow, and 3) they have a universal mounting bracket and can be DIN rail mounted for fast installation without the need for drilling and tapping pre-aligned hole patterns, or they can be attached with standard bolts.

Use a thermal conduction grease or a thermal pad in order to achieve the proper heat sinking capability between the SSR and the heat sinks shown below.

### Part Number: Heatsk-Din-1.0

(for most 35-60 amp applications)  
1.0°C/W capability

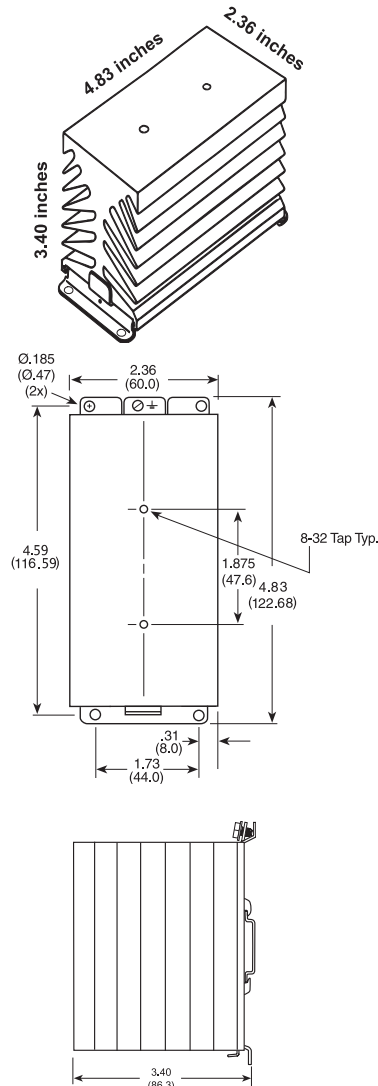

### Part Number: Heatsk-Din-1.6

(for most 10-40 amp applications)  
1.6°C/W capability

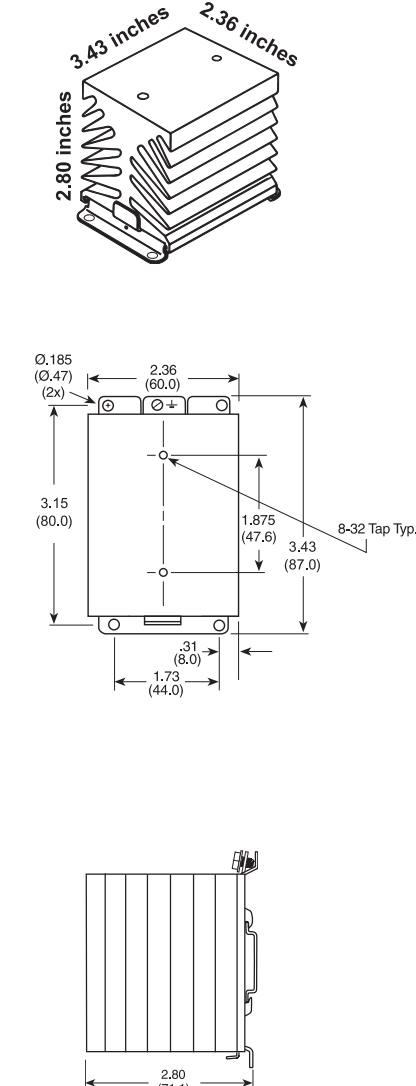

### Part Number: Heatsk-6pk-1.2

(for most 8-60 amp applications)  
1.2°C/W capability

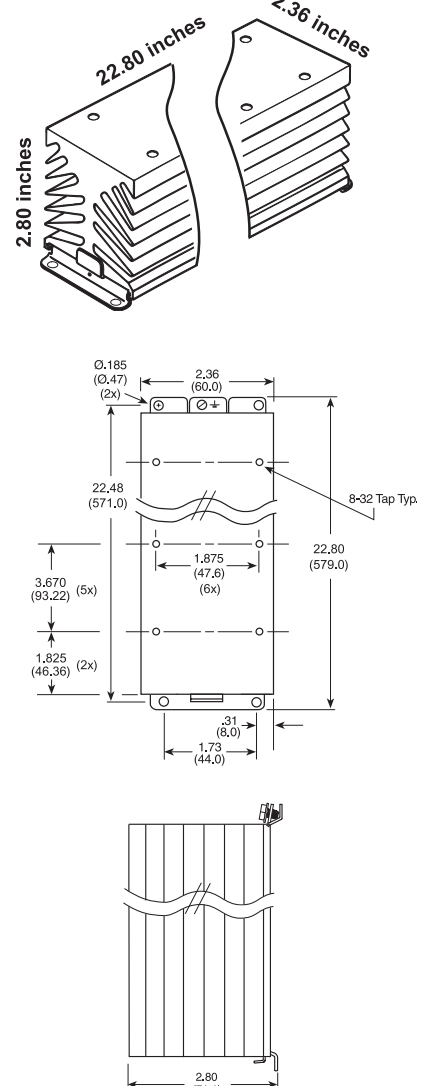



# RV Series Single Phase DIN Rail Mount Relays

## FEATURES/BENEFITS

- Superior Surge Survival™ technology
- 25 or 40 amp ratings
- 575 or 660Vac max.
- Integrated heat sink
- LED input indicator
- Direct copper bonded
- Meets EN60947-4-3 and EN55011
- UL recognized, CSA listed, CE approved

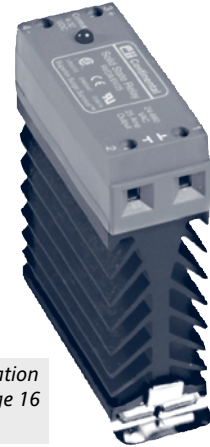

## SPECIFICATIONS

<b>Load type:</b>	Resistive
<b>Input:</b>	
<b>RVDA–DC Input:</b>	ON ≥ 4Vdc/3.5mA, 32Vdc/8mA max, current limited OFF ≤ 1Vdc
<b>RVAA–AC Input:</b>	ON ≥ 100V, 280Vac max., 9-25mA OFF ≤ 20Vac/2mA, 10kΩ impedance
<b>Output:</b>	
<b>Current ratings:</b>	25 or 40 Amps
<b>Voltage ratings:</b>	5V-24V to 575V max. (internal MOV), 6V-24V to 660V max.
<b>Frequency:</b>	47-63Hz
<b>Voltage drop:</b>	25A-1.0Vac, 40A-1.2Vac
<b>I<sup>2</sup>t rating:</b>	1350 A <sup>2</sup> sec
<b>Leakage:</b>	10mA max.
<b>Holding current:</b>	100mA
<b>Peak blocking voltage:</b>	1400V
<b>Offstate dVdT:</b>	1000V/μsec
<b>Turn on/off time:</b>	< 8.3ms @ 60Hz
<b>Operating temperature:</b>	0°C to 40°C (up to 80°C with derating)

See page 18 for installation considerations and page 16 for fuse selector chart.

## ORDERING CODES

Model	Rating
RVDA	DC input
RVAA	AC input
5V25	575V 25 amp
6V25	660V 25 amp
5V40	575V 40 amp
6V40	660V 40 amp

## DERATING CURVES

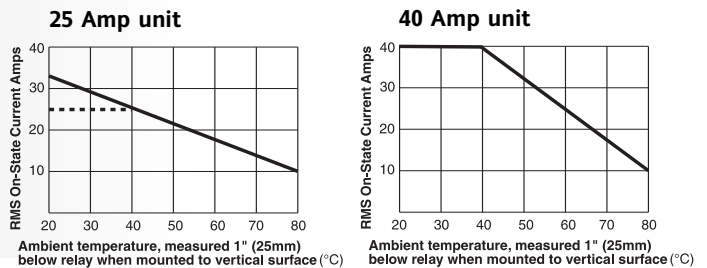

## SCHEMATIC/DIMENSIONS

### DC Input

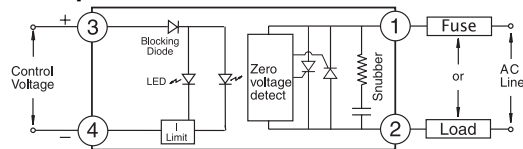

### AC Input

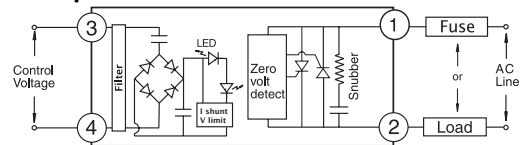

### Front View

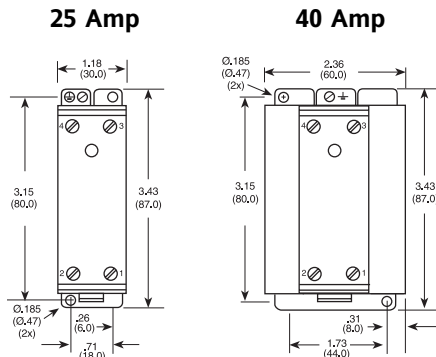

### Side View 25 and 40 Amp

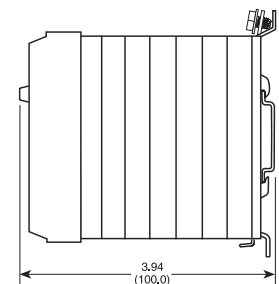



# RS Series Single Phase DIN Rail Mount Relays

## FEATURES/BENEFITS

- Automatic shutdown on overtemperature
- Built-in, replaceable, semiconductor fuse
- Integrated heat sink
- Mounts on DIN rail or panel
- Optically isolated
- Touch safe
- LED indicator (function and alarm)
- Built-in snubber
- 4000 volt isolation
- Zero voltage turn on
- Direct copper bonded
- UL recognized, CSA listed, CE approved
- 100% tested

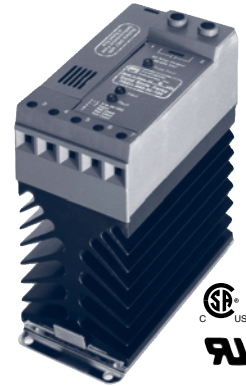

50 Amp



## SPECIFICATIONS

<b>Load type:</b>	Resistive
<b>Input:</b>	
<b>RSDA-DC Input:</b>	ON $\geq$ 4Vdc/6mA, 28Vdc/9mA max OFF $<$ 1Vdc
<b>RSAA-AC Input:</b>	ON $\geq$ 100V, 280Vac max., 5-15mA max. OFF $<$ 20Vac, 2mA, 10k $\Omega$ impedance
<b>Output:</b>	
<b>Current ratings:</b>	50, 75 or 100 amps
<b>Voltage ratings:</b>	24V to 660V max.
<b>Frequency:</b>	47-63Hz
<b>Voltage drop:</b>	1.3Vac
<b>Pt rating:</b>	50-7,200; 75-15,000; 100-20,000
<b>Leakage:</b>	8mA
<b>Holding current:</b>	50A-50mA, 75A-100mA, 100A-100mA
<b>Peak blocking voltage:</b>	1200V
<b>Operating temperature:</b>	0°C to 40°C (up to 80°C with derating)



75 Amp



## DERATING CURVE

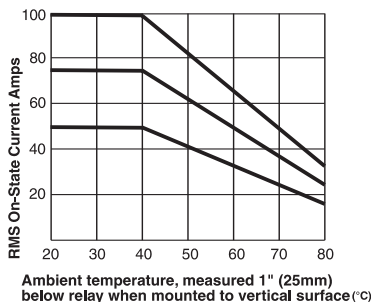

100 Amp





# RS Series Single Phase DIN Rail Mount Relays

## SCHEMATICS

### DC Input

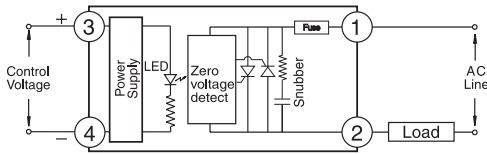

### AC Input

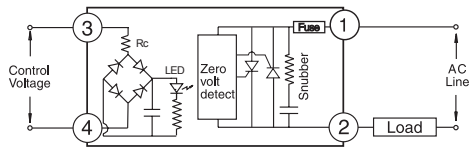

## ORDERING CODES

Model	Rating
RSDA 4-28Vdc input, AC output	660-50-100 660V 50 amp 660-75-100 660V 75 amp
RSAA 100-280Vac input, AC output	660100-100 660V 100 amp 660100-B00 660V 100 amp

See page 16 for spare fuse selector chart.

## DIMENSIONS

### 50 Amp

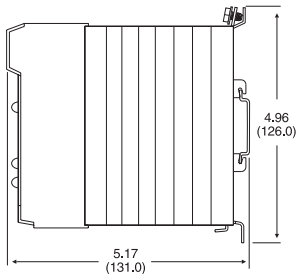
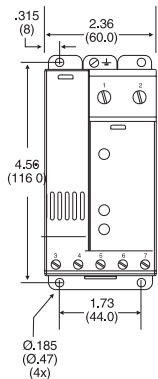

### 75 Amp

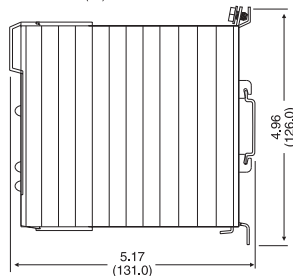
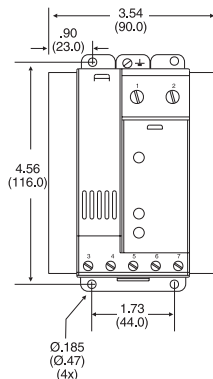

### 100 Amp

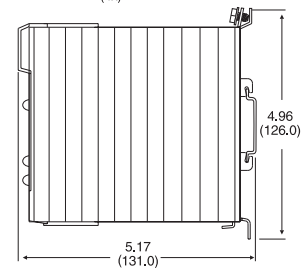
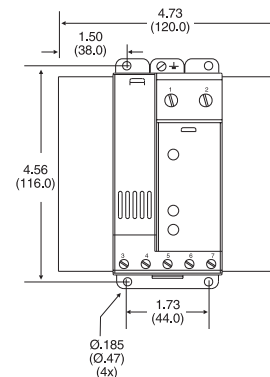

### Notes:

- Standard product features internal fuses.
- The -B00 option substitutes a copper bus bar in place of the internal I<sup>2</sup>T fuse. This permits the RSAA/RSDA to be operated on higher amperage applications without concern about fuse derating due to heat. Order the external fuse and fuseblock as a separate line item. See page 16. Consult factory regarding the 100 amp-B00 option.

### Terminals:

- Input:
- Will accept #24-10 AWG wire
  - Torque to 7-9 inch lbs.
- Output:
- Will accept #8-3 AWG wire
  - Torque to 40 inch lbs.



# RVMA Series of Milliamp Input Single Phase DIN Rail Mount Relays

## FEATURES/BENEFITS

- Superior Surge Survival™
- 25 or 40 amp ratings
- 575 or 660Vac max.
- Integrated heat sink
- Mounts on DIN rail or panel
- LED indicator
- Zero voltage turn-on
- Direct copper bonded
- Meets EN60947-4-3
- UL recognized, CSA listed, CE approved
- 100% tested

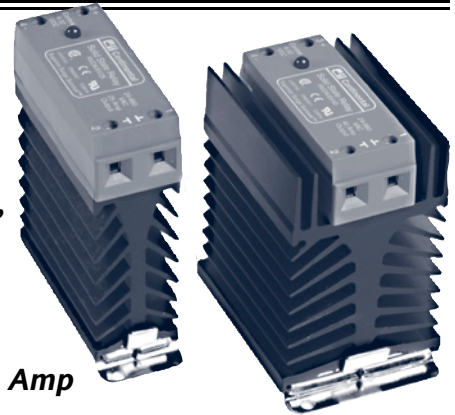

## SPECIFICATIONS

<b>Load type:</b>	Resistive
<b>Input:</b>	4-20mA, 6Vdc max. drop @20mA
<b>Output:</b>	
<b>Current ratings:</b>	25 or 40 amps
<b>Voltage ratings:</b>	5V-24V to 575V max. (internal MOV), 6V-24V to 660V max.
<b>Frequency:</b>	47-63Hz
<b>Voltage drop:</b>	25A-1.0Vac, 40A-1.2Vac
<b>I<sup>2</sup>t rating:</b>	1350 A <sup>2</sup> sec
<b>Leakage:</b>	10mA max.
<b>Holding current:</b>	100mA
<b>Peak blocking voltage:</b>	1400V
<b>Offstate dVdT:</b>	1000V/μsec
<b>Turn off time:</b>	<8.3msec @ 60Hz
<b>Operating temperature:</b>	0°C to 40°C (up to 80°C with derating)
<b>Operation:</b>	4mA=0%, 12mA=50% (250ms on/off), 16mA=75% (375ms on/125ms off), 20mA=100% (on continuous)

25 Amp

40 Amp



See page 18 for installation considerations.  
See page 16 for fuse selector chart.

## ORDERING CODES

Model	Rating
RVMA	6V25 660V 25 amp 6V40 660V 40 amp 5V25 575V 25 amp 5V40 575V 40 amp

## DERATING CURVES

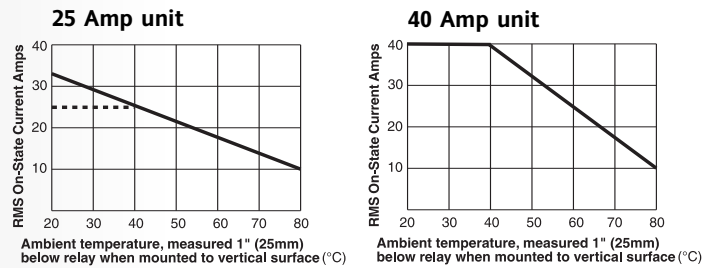

## SCHEMATIC/DIMENSIONS

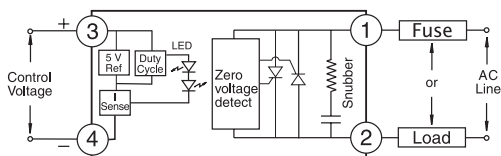

### Terminals:

- Will accept #24-10 AWG wire
- Torque to 7-9 inch lbs.

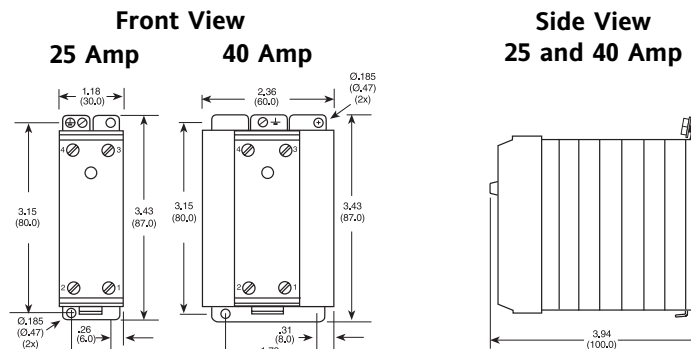

# RVx3 Series Solid State Contactors

## FEATURES/BENEFITS

- Superior Surge Survival™
- 25 amp rating
- 575 or 660Vac designs
- Integrated heat sink
- Optically isolated
- LED input indicator
- Direct copper bonded
- 1400 volt peak blocking voltage
- Meets EN60947-4-3
- UL recognized, CSA listed, CE approved
- 100% tested



See page 18 for installation considerations.  
See page 16 for fuse selector chart.

## SPECIFICATIONS

<b>Load type</b>	Resistive
<b>Input:</b>	
<b>RVD3-DC Input (L):</b>	ON $\geq$ 4Vdc/10mA, 32Vdc/15mA max, current limited OFF $\leq$ 1Vdc
<b>RVD3-DC Input (H):</b>	ON $\geq$ 10Vdc/3.5mA, 60Vdc/6mA max, current limited OFF $\leq$ 1Vdc
<b>RVA3-AC Input (H):</b>	ON $\geq$ 100V/9mA, 280Vac/30mA max. OFF $\leq$ 2mA, 10k $\Omega$ impedance
<b>Output:</b>	
<b>Current ratings:</b>	25 amps (3 pole), 30 amps (2 pole):
<b>Voltage ratings:</b>	5V-24V to 575V max. (internal MOV) 6V-24V to 660V max.
<b>Frequency:</b>	47-63Hz
<b>Voltage drop:</b>	1Vac per leg
<b>I<sup>2</sup>t rating:</b>	1350 A <sup>2</sup> sec
<b>Leakage:</b>	1mA max
<b>Holding current:</b>	100mA
<b>Peak blocking voltage:</b>	1400V
<b>Offstate dVdT:</b>	100V/ $\mu$ sec
<b>Turn on/off time:</b>	< 8.3ms @ 60Hz
<b>Operating temperature:</b>	0°C to 40°C (up to 80°C with derating)

## ORDERING CODES

Model	Rating	Input
RVD3	DC logic	4-32Vdc
RVA3	AC logic	10-60Vdc
		90-280Vac

Model	Rating
5V75T	575Vac, internal MOV
6V75T	660Vac

## SCHEMATIC/DIMENSIONS

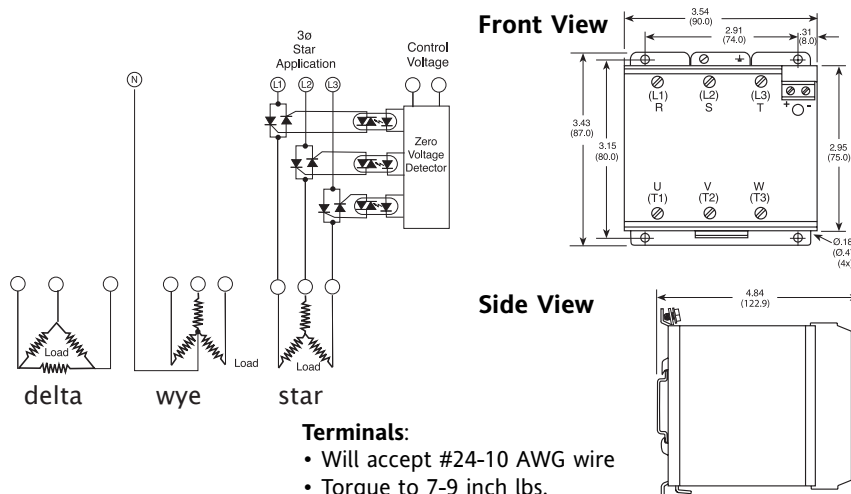

## DERATING CURVES

### 2 Leg and 3 Leg

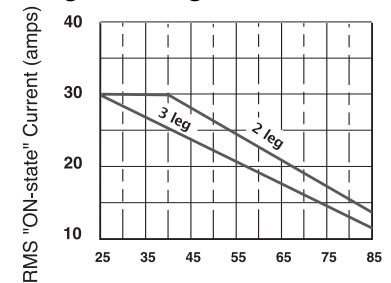

Ambient temperature (°C), measured 1 inch (25mm) below relay when mounted to DIN rail or a vertical, 1/8th inch thick aluminum panel surface. Airflow is unrestricted up and through the heat sink.



# RVM3 Series Solid State Contactor

## FEATURES/BENEFITS

- Superior Surge Survival™
- 25 amp rating
- 575 or 660Vac ratings
- Integrated heat sink
- Optically isolated
- LED input indicator
- Direct copper bonded
- 1400 volt peak blocking voltage
- Meets EN60947-4-3
- UL recognized, CSA listed, CE approved
- 100% tested

## SPECIFICATIONS

<b>Load type:</b>	Resistive
<b>Input:</b>	4-20mA, 10V max. drop @ 20mA
<b>Output:</b>	
<b>Current ratings:</b>	25 amps (3 pole), 30 amps (2 pole)
<b>Voltage ratings:</b>	5V option: 24V to 575V max. (internal MOV) 6V option: 24V to 660V max.
<b>Frequency:</b>	47-63Hz
<b>Voltage drop:</b>	1Vac per leg
<b>I<sup>2</sup>t rating:</b>	1350A <sup>2</sup> sec
<b>Leakage:</b>	10mA max.
<b>Holding current:</b>	100mA
<b>Peak blocking voltage:</b>	1400V
<b>Offstate dVdt:</b>	1000V/μsec
<b>Dielectric strength:</b>	4000V <sub>RMS</sub>
<b>Turn on/off time:</b>	< 8.3ms @ 60Hz
<b>Operation:</b>	4mA=0%, 12mA=50% (250ms on/off), 16mA=75% (375ms on/125ms off, 20mA=100% (on continuous)
<b>Operating temperature:</b>	0°C to 40°C (up to 80°C with derating)



See page 18 for installation considerations.  
See page 16 for fuse selector chart.

## ORDERING CODES

Model	Rating
RVM3	

  

Model	Rating
RVM3 3 phase mA unit	5V75T 575Vac, internal MOV 6V75T 660Vac

## SCHEMATIC/DIMENSIONS

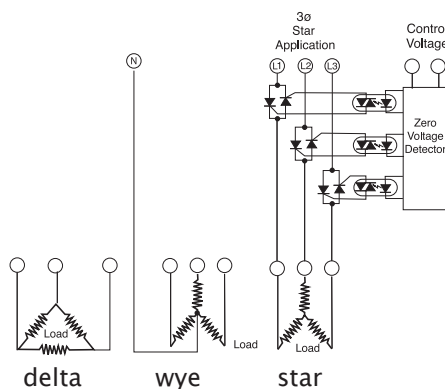

- Terminals:**
- Will accept #24-10 AWG wire
  - Torque to 7-9 inch lbs.

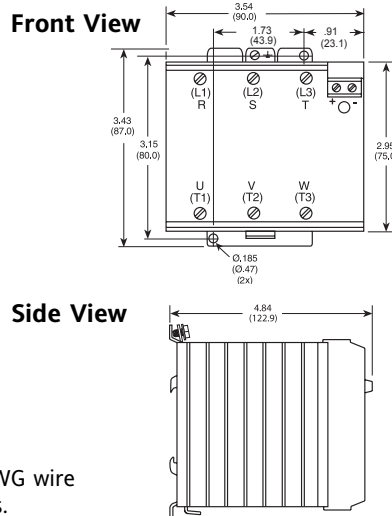

## DERATING CURVES

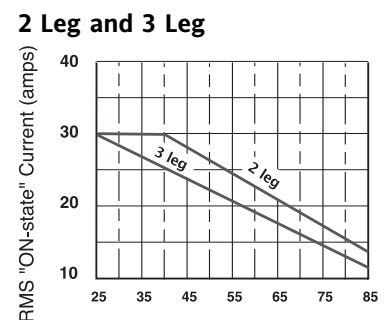

Ambient temperature (°C), measured 1 inch (25mm) below relay when mounted to DIN rail or a vertical, 1/8th inch thick aluminum panel surface. Airflow is unrestricted up and through the heat sink.

# Mini DIN Rail Mount Input Modules

## FEATURES/BENEFITS

- High density design
- Wide logic voltage range
- LED logic indicator
- Color coded cases
- Positive or negative logic
- Optically isolated
- TTL compatible
- 4000 volt isolation
- 100% tested
- UL recognized, CSA listed, CE approved
- Meets EN60950

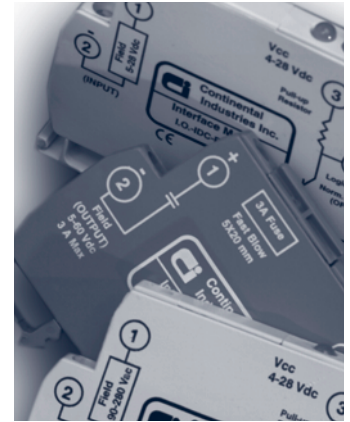

Part Number	Case Color	Input Voltage	Logic Type	Output Voltage	Max Load Current	Turn On Time Max	Turn Off Time Max	Output Voltage Drop @ 100mA
I.O.-IAC-R0-280	Yellow	90-280 Vac	Negative	4-28 Vdc	100 mA	20 ms	20 ms	0.5 Vdc
I.O.-IAC+R0-280	Yellow	90-280 Vac	Positive	4-28 Vdc	100 mA	20 ms	20 ms	0.5 Vdc
I.O.-IDC-R0-028	White	4-28 Vdc	Negative	4-28 Vdc	100 mA	30 $\mu$ s	60 $\mu$ s	0.5 Vdc
I.O.-IDC+R0-028	White	4-28 Vdc	Positive	4-28 Vdc	100 mA	30 $\mu$ s	60 $\mu$ s	0.5 Vdc

- 4000 V<sub>RMS</sub> isolation field to logic on all model numbers
- Operating temperature 0-70°C

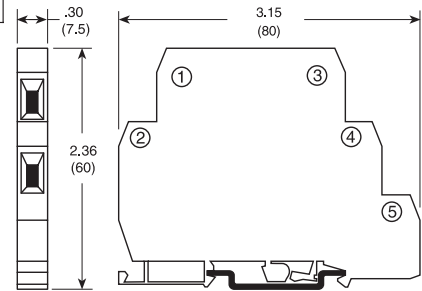

## SCHEMATICS

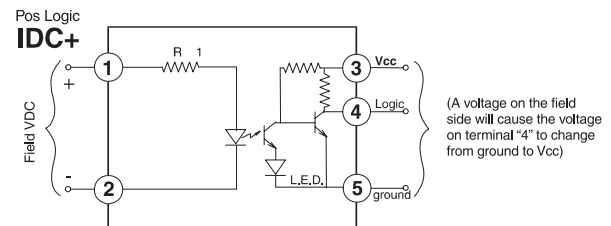
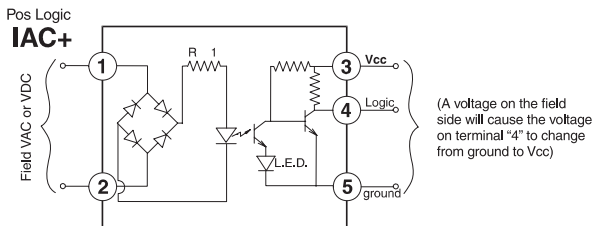
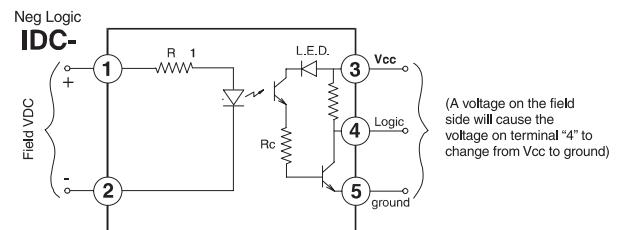
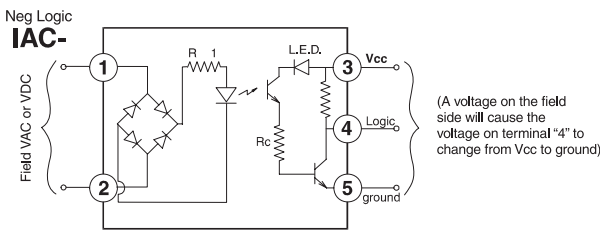

### Terminals:

- Will accept #24-10 AWG wire
- Torque to 5-7 inch lbs.

See jumper strip and marker card accessories on page 15 for easy, trouble free wiring and identification.

Module Logic	Field Voltage?	Logic Voltage Signal (Terminal 4)
Negative	Yes	No
Negative	No	Yes
Positive	Yes	Yes
Positive	No	No



# Mini DIN Rail Mount Output Modules

## FEATURES/BENEFITS

- High density design
- Wide logic voltage range
- Fused output
- LED logic indicator
- Color coded cases
- Optically isolated
- TTL compatible
- 4000 volt isolation
- 600 volt peak blocking voltage
- 100% tested
- UL recognized, CSA listed, CE approved
- Meets EN60950

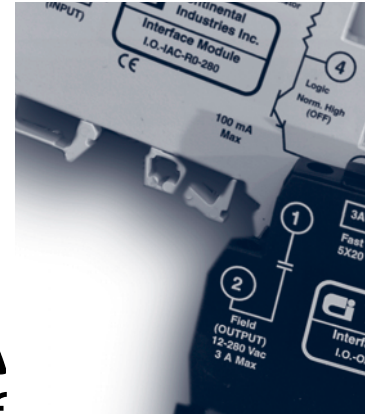

Part Number	Case Color	Input Voltage	Logic (Input) Impedance	Output Voltage	Output Current @ 45° C	Leakage Current @ Max Field Voltage	Voltage Drop @ Max I <sub>out</sub>
I.O.-OAC-R0-280	Black	4-28 Vdc	1.5K Ohms	12-280 Vac	0.10-3A <sub>rms</sub> *	5 mA	1.65 Vac
I.O.-OAC-RA-280	Black	90-280 Vac	40K Ohms	12-280 Vac	0.10-3A <sub>rms</sub> *	5 mA	1.65 Vac
I.O.-ODC-R0-060**	Red	4-28 Vdc	1.5K Ohms	5-60 Vdc	0-3A*	1 mA	1 Vdc
I.O.-ODC+RL-060***	Red	4-28 Vdc	1.5K Ohms	5-60 Vdc	0-3A*	100 μA	1 Vdc

- 4000 V<sub>RMS</sub> isolation field to logic on all model numbers
- Operating temperature 0-70°C
- 3 amp 5x20mm Fast Fuse, replaceable

\* The 3 amp output is obtained when there is <45°C ambient air surrounding all sides of the module. De-rate the output if the ambient temperature is higher and/or if the modules are tightly stacked together.

\*\* Turn On Time - 40μs, Turn Off Time - 40μs  
 \*\*\* Turn On Time - 50μs, Turn Off Time - 100μs

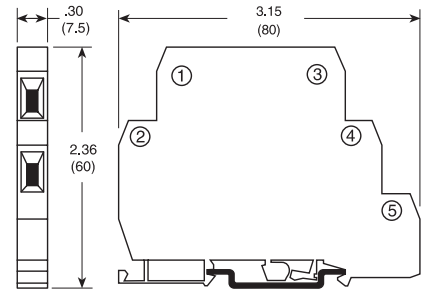

## SCHEMATICS

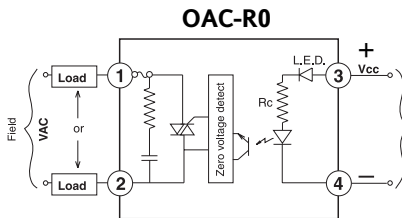

Application of a voltage here will cause the load to turn on.

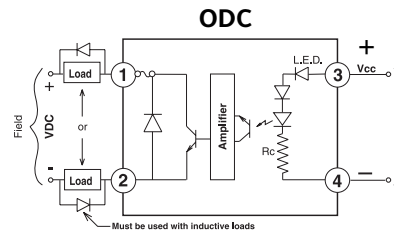

Application of a voltage here will cause the load to turn on.

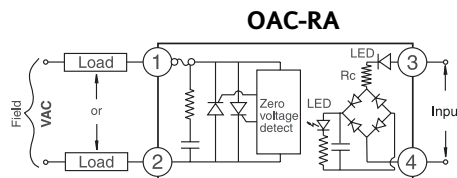

Application of a voltage here will cause the load to turn on.

### Terminals:

- Will accept #24-10 AWG wire
- Torque to 5-7 inch lbs.

See jumper strip and marker card accessories on page 15 for easy, trouble free wiring and identification.



# Mini DIN I.O. Module Accessories

## Jumper Strips

Continental Industries' 10 position jumper strips are for use with our Mini DIN I/O Modules (pages 13-14). They are used to interconnect the positive and/or negative logic terminals, eliminating the need to use small jumper wires. The strips are copper plated and insulated, and can be cut to length as desired. Part Number I.O.-JUMPER-010

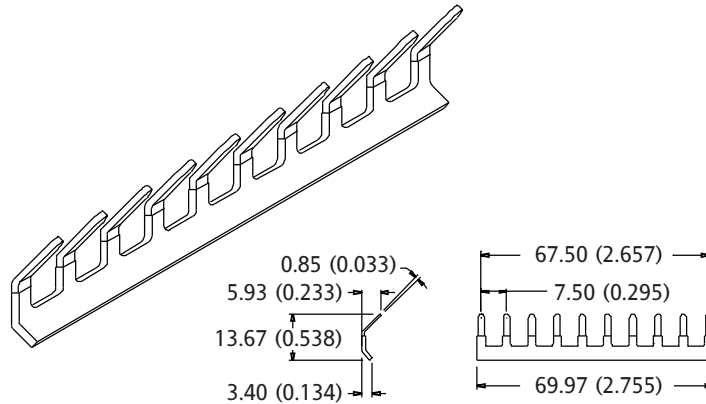

## Marker Cards

Marker tags snap into the slots on the edge of a Mini I/O module for easy identification. Customers benefit from easy, clear identification. Marker tags are available as cards, each with 5 sets of 10 characters (i.e. numbers 1-10, five times). Number ranges are: 1-10 or 11-20. Some customers install their I/O modules on every other number (1, 3, 5, 7, 9) in order to ensure air flow around each I/O module.

Part Numbers:

- I.O.-MARKER-001 (Numbers 1-10)
- I.O.-MARKER-011 (Numbers 11-20)

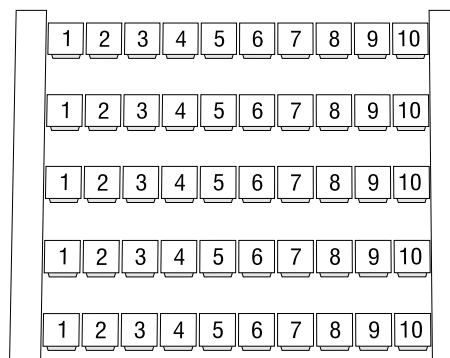



# Semiconductor Fuses & Fuse Holders

## FEATURES/BENEFITS

- Touch safe design - No exposed contacts
- DIN rail mount (35mm)
- Excellent for switchboard panel, control consoles and similar applications
- Handle/fusepuller to install and remove fuses easily
- Available in single and 3 pole configurations
- UL recognized, CSA listed, CE approved

Use the solid state relay fuse code to select the correct fuse and fuse holder, or replacement fuse. Protecting solid state relays from short circuit conditions is the main job of an I<sup>2</sup>T semiconductor fuse, not providing overload protection. Continental Industries' recommended fuses have been selected to provide the best match of short circuit protection over a wide range of operating voltages and ambient temperatures. Applying overload protection is specific to every application. Always consult applicable electrical codes for guidance in selecting an appropriate "overload protection" device, fuse, or circuit breaker. See page 24 for further fusing considerations.



## FUSE SELECTOR CHART

Semiconductor Fuse Replacements & Accessories			Used with:
<b>External:</b>	<b>Fuse and Fuse Holder</b>		
	FUSE-KIT-14-010	10 Amp	SV Series
	FUSE-KIT-14-025	25 Amp	SV, RV Series
	FUSE-KIT-14-330	30 Amp/3 Phase/3 Pole	RS 3 Phase
	FUSE-KIT-14-040	40 Amp	RV25, RV40, SV50
	FUSE-KIT-14-050	50 Amp	SV50
	FUSE-KIT-22-063	63 Amp	RS50
	FUSE-KIT-22-075	80 Amp	SV75
	FUSE-KIT-22-100	100 Amp	RS75, RS100
<b>Fuse only (I<sup>2</sup>T fuse)</b>			
<b>Internal fuses <sup>(1)</sup>:</b>	FUSE-SEMIBR-63A	63 Amp	RS50
	FUSE-SEMIBR-100	100 Amp	RS75, RS100
<b>External fuses <sup>(2)</sup>:</b>	FUSE-EXT-14-010	10 Amp	SV Series
	FUSE-EXT-14-025	25 Amp	SV, RV Series
	FUSE-EXT-14-030	30 Amp	RS 30 Amp/3Phase
	FUSE-EXT-14-040	40 Amp	RV40, SV50
	FUSE-EXT-14-050	50 Amp	SV50
	FUSE-EXT-22-063	63 Amp	RS50
	FUSE-EXT-22-075	80 Amp	SV75
	FUSE-EXT-22-100	100 Amp	RS75, RS100
<b>Fuse Holders Only</b>			<b>Dimensions H x W x D in (mm)</b>
	FUSE-HLDR-14-01	10-50 Amp	3.74 x 1.02 x 3.38 (95 x 26 x 86)
	FUSE-HLDR-22-01	75-100 Amp	5.51 x 1.38 x 3.54 (140 x 35 x 90)
	FUSE-HLDR-14-03	30 Amp/3 Phase	3.74 x 3.11 x 3.38 (95 x 26 x 86)
<b>Handle (Gang3)</b>	FUSE-3HANDLE-00	30 Amp/3 Phase	

**Notes:**

(1) The internal fuses are used in the RS family of 50, 75, and 100 Amp relays. Due to local electrical codes or due to thermal stress on the fuse, some customers may choose to use the external fuse and fuse holder #FUSE-KIT-22-063 or -100.

(2) The external fuses are 14mm diameter x 51 mm long or 22mm diameter x 58mm long.

Contact Continental Industries for the internal bus bar, -B00 option.

# Application Notes

## Safety Cover

Continental Industries' safety covers meet European touch safety requirements and can be used on any of the SV, S505-, SS- series or RSDC units. The covers snap on, forming a tight fit. Holes in the lid provide easy access for probe testing. Safety covers are included with the SV-Series.

Part Number: COVR-SAFETY-000

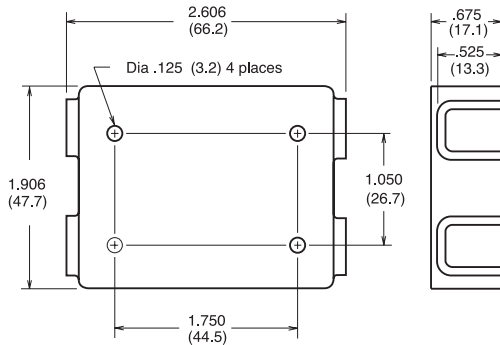

## Thermal Transfer Pads

Our thermal transfer pads are die-cut to fit the bases of Continental Industries' panel mount relays. They are an excellent replacement for thermal greases, and are proven to provide the lowest thermal resistance values of any commercially practical interface material, while being more convenient and less messy. Available in sets of 5 and 25.

Part Numbers: THERMAL-PAD-005 (5 pcs)  
THERMAL-PAD-025 (25 PCS)

- 60°C Phase Change Temperature
- Total Interface Pad Thickness = 3 mils
- Lowest Contact Thermal Impedance Available
- No "run out" in vertical mounting applications
- Heat sensitive material, store below 30°C (85°F)
- Ruggedized material that is resistant to handling damage while in transit

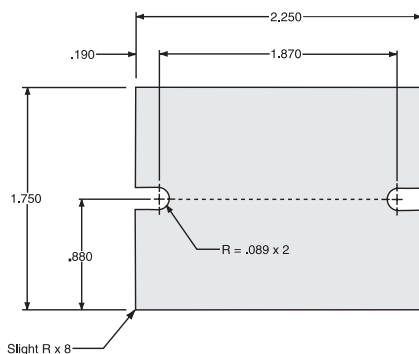

## Heat Sinking (also see page 6)

Heat is generated by all Solid State Relays in direct relation to the amount of current being switched. Approximately 0.8-1.4 Watts will be generated by the SSR for every Amp switched. This heat must be dissipated as fast as generated otherwise the temperature will increase until the relay fails. Approximately 90% of all problems with relays are directly related to heat.

**Adequate heat sinking, including consideration of air temperature and flow, is essential** to the proper operation of a solid state relay. Units should never be mounted in an enclosed area without proper air flow. Units should also never be mounted to a plastic base or to a painted surface. **Failure to provide adequate heat sinking will cause a solid state relay to fail.** We recommend mounting our units on the heat sinks listed on page 6 of this catalog. However, when this is not possible, and the units are to be mounted to some other heat sinking object, material heat conductivity should be kept in mind. In heat dissipation, our heat sinks are approximately equivalent to a sheet of aluminum 1/8" thick by the dimensions shown:

HEATSK-DIN-1.6	10" x 10"	(254 x 254mm)
HEATSK-DIN-1.0	14" x 14"	(355.6 x 355.6mm)

(Given proper ventilation and ambient temperature.)

In comparison, **twice the amount of steel and four times the amount of stainless steel** would be needed to achieve the same effect.

Any panel mount Solid State Relay must be mounted to a clean, bare (non-painted) surface that is free of oxidation.

Since even the best heat sink surfaces have some imperfections, there will be many air pockets between the base of the relay and the heat sink (or panel) surface.

Air is a very poor conductor of heat and will cause the relay to run hotter than it should. To fill these pockets, **Thermal Transfer Pads (see column 1, pg 17) should be placed on the metal base of the relay before mounting to a metal surface.** We suggest torque of 10 inch-pounds on both of the SSR mounting screws.

Alternately, an evenly applied 0.002" thick layer of Dow Corning 340 (or equivalent) can be used. Note that a thicker layer of thermal compound actually decreases heat transmission.

Since airflow will affect its performance, a heat sink should be mounted in a manner that assures unrestricted airflow over its surface. Recommended mounting is on a vertical metal surface, with the fins oriented vertically so that air can flow unimpeded along the surfaces of the heat sink. Horizontal or inverted mounting is possible but not recommended, and the SSR must be derated accordingly.



# Application Notes

Care must be taken when mounting multiple SSRs in a confined area. SSRs should be mounted on individual heat sinks whenever possible. Panel mount SSRs should never be operated without proper heat sinking or in free air as they will THERMALLY SELF DESTRUCT UNDER LOAD.

A simple method for monitoring temperature is to slip a thermocouple under a mounting screw. If the base temperature does not exceed the “max heat sink temperature” (shown in column 2, pg 18) under normal operating conditions, the SSR is operating in an optimal thermal environment. If this temperature is exceeded, the relays current handling ability must either be thermally improved by the use of a larger heat sink, or greater air flow must be provided over the device through the use of a fan. Some cases may require the selection of a higher current output SSR and thermally derating the device accordingly.

Remember that the heat sink removes the heat from the Solid State Relay and transfers that heat to the air in the electrical enclosure. In turn, this air must circulate and transfer its heat to the outside ambient. Providing vents and/or forced ventilation is a good way to accomplish this.

### 80% Power Rule

All Solid State Relays are capable of running at full rated power (with proper heat sinking). However, it is strongly suggested that they be used at no more than 80% power to provide a safety margin in case of higher than expected voltage, temperature, or dust on the heat sink, etc. Additionally, voltage can vary up to +/-10%, and a heating element up to +/-10% over its life—two main reasons for the 80% rule.

### DIN Mounted Single and Three Phase Relays

The RS and RV series are provided with integral heat sinks. The RS units should be mounted so as to provide 1” (25mm) of space between the units, for best air flow (the 80% of power rule described above still applies). They can be mounted against each other if the end units in a row are derated by 10% and the middle units are derated 10% more than the end ones.

On the other hand, the RV units can be installed on a DIN-rail with only 0.18 inches between relays, “Fin-to-Fin”! The RV family provides more amps per square inch than other brands of industrially hardened SCR controllers and will perform better in installations with higher ambient temperatures.

For proper airflow, the RS and RV units should both be mounted in a manner leaving space above and below the heat sink equal to or greater than the height of the heatsink. Since airflow will affect performance, relays with integral heat sinks should be mounted in a manner providing unrestricted airflow over their surfaces. Recommended mounting is on a vertical surface, with the fins oriented vertically, so that air can flow unimpeded along the surfaces of the heat sink.

## Heat Sink Calculations for SV Family of Solid State Relays

### Continental Industries SV Power Dissipation

SVxA/3V10 10 Amp Relays	SVxA/3V25 25 Amp Relays
10A/11W	25A/31W
8A/9W	20A/23W
6A/6W	15A/16W
4A/4W	10A/10W
2A/2W	5A/5W
Max heat sink=90°C Pwr Ref: V <sub>o</sub> =0.80V <sub>o</sub> Rt=0.038 Ω	Max heat sink=85°C Pwr Ref: V <sub>o</sub> =0.80V <sub>o</sub> Rt=0.021 Ω
SVxA/3V50 50 Amp Relays	SVxA/3V75 75 Amp Relays
50A/59W	75A/84W
40A/44W	60A/63W
30A/30W	45A/44W
20A/18W	30A/27W
10A/9W	15A/13W
Max heat sink=105°C Pwr Ref: V <sub>o</sub> =0.80V <sub>o</sub> Rt=0.0092 Ω	Max heat sink=105°C Pwr Ref: V <sub>o</sub> =0.85V <sub>o</sub> Rt=0.0046 Ω

All calculations are in °C. See derating curves on next page. Continental Industries provides three ways to calculate the heat sink for your application.

### 1) Heat Sink Calculation Method

Maximum heat sink temperature minus maximum ambient temperature divided by the power dissipation (use the chart above for power dissipation at desired current).

(Max Heat Sink Temp - Max Ambient Temp) / Watts = \_\_\_\_

For Example, use an

- SVDA/3V25 running at 20 Amps in a 45°C ambient
- From the chart, at 20 Amps it dissipates 23 Watts
- A 25A unit can have an 85°C heat sink
- (85-45 ambient) = 40°C temp rise is allowed
- 40°C/23W = 1.74°C/W heat sink rating or less (less temperature rise per watt is better)
- Therefore, the recommended heat sink would be part number: HEATSK-DIN-1.6 (rated at 1.6°C/W) or any equivalent heat sink that is 1.74 or LESS. Remember, the lower the heat sink value, the better it dissipates the heat. The relay must be connected to the heat sink using an appropriate thermal conduction grease or thermal pad.

# Application Notes

## 2) De-Rating Calculation Method

Maximum heat sink temperature minus maximum ambient temperature divided by the heat sink rating (use the previous chart for power dissipation).

$$\frac{(\text{Max Heat Sink Temp} - \text{Max Ambient Temp})}{\text{Heat sink rating}} = \text{Max allowed Watts}$$

For Example, use an

- SVDA/3V10 in a 60°C ambient with a 2.0°C/W heat sink.
- 90°C - 60°C = 30°C heat sink temperature rise is allowed.
- 30°C divided by 2.0°C/W = 15W.
- From the table, full load current of 10A only dissipates 11W.
- Thus, an SVDA/3V10 mounted on a 2.0°C/W heat sink can switch 10A at 60°C.

## 3) Power Calculation in Place of the Charts

Heat rise calculation of an SV solid state relay based upon amperage switched "ON" 100% of the time. Please note, the Continental Industries "SV" SSR uses engineering techniques that provide maximum surge survivability while generating a low temperature rise.

$$(0.9 \times I_{\text{RMS}} \times V_o) + (I_{\text{RMS}}^2 \times R) = \text{Power}$$

For Example, use an

- SVDA/3V25 for a 21A application.
- $(0.9 \times 21\text{A} \times 0.80\text{V}) + (21^2 \times 0.021\Omega) = 24.4 \text{ W}$

### SV Family Solid State Relay Power Curves

#### 10 Amp Relay

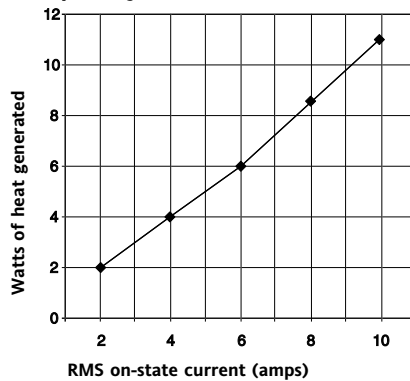

#### 25 Amp Relay

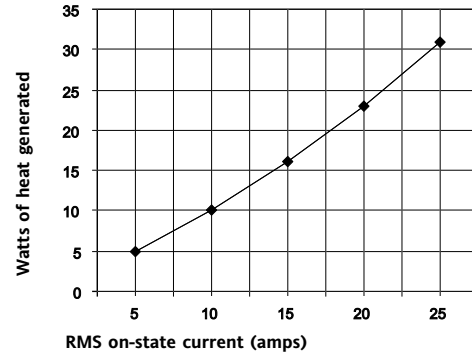

#### 50 Amp Relay

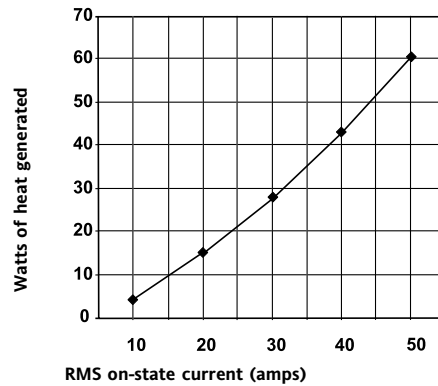

#### 75 Amp Relay

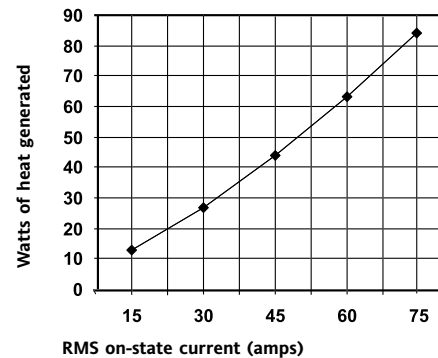

## Motor Applications (RV - 3 Phase Unit)

The Continental Industries 3 phase solid state relay is designed for switching power to 3 phased asynchronous motors and to resistive loads. For guidance in its application, refer to the following notes:

### (380 Volt, 50/60Hz Motors - Direct Start)

	Motor Size (KW)	Start Current ( $A_{RMS}$ )	Operating Current ( $A_{RMS}$ )
2-Pole - 3000 RPM	3	43.4	6.2
4-Pole - 1500 RPM	3	38.0	6.9
6-Pole - 1000 RPM	4	47.7	9.0
8-Pole - 750 RPM	3	36.6	8.7

### (220 Volt, 50/60Hz Motors - Direct Start)

2-Pole - 3000 RPM	2.2	45.0	7.0
-------------------	-----	------	-----

## Overload Capacities

In the event that a load completely or partially short circuits, the following table indicates the absolute maximum current that the 3 Phase RV-Unit relay can withstand for various time limits:

Time (Sec)	Current ( $A_{RMS}$ )	Time (Sec)	Current ( $A_{RMS}$ )
.2	275	8.0	80
.4	228	10.0	75
.6	188	12.0	72
.8	161	14.0	71
1.0	150	16.0	70
2.0	124	18.0	69
4.0	95	20.0	67
6.0	86	40.0	58

## Three Phase Motor Control (SV Series)

Three phase motors can be controlled as shown. Note that only two SSRs are required (the third is optional). The inputs are shown in parallel, but they can also be connected in series as long as the minimum control voltage is provided to power each relay.

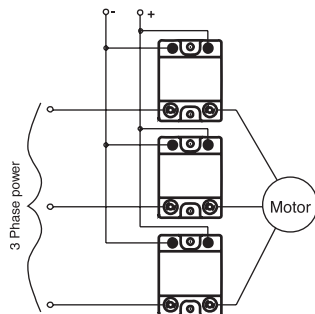

## Three Phase Wiring Suggestions

Relay positioning in a three-phase circuit impacts the current draw and therefore the amount of heat generated. When positioned in location "A", as indicated below, a relay will draw 73.2% more current than position "B". Using position "B" will enable the use of a smaller relay or will provide an increased safety margin. Additionally, by drawing less current, heat generation is reduced by 40%.

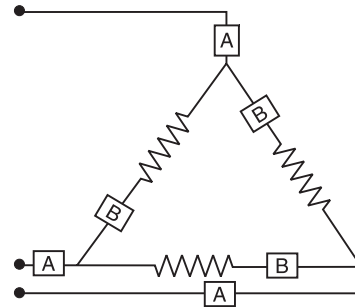

## Example Wiring (RV-3 Phase Unit)

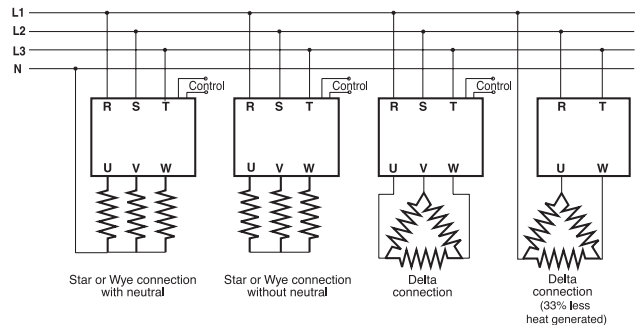

Maximum wattage is less with Delta configuration

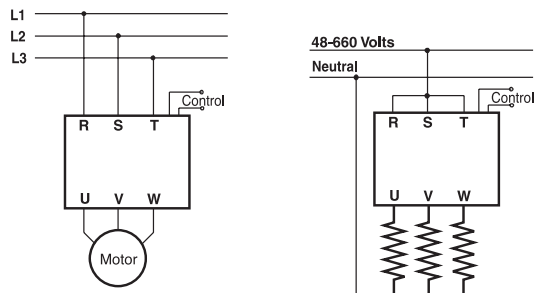



# Application Notes

## Logic Signal (TTL) Operation

One of the primary advantages of SSRs and I/O modules is their compatibility with low level, solid state logic. Any logic gate, buffered or not, capable of delivering the required current and voltage within its maximum power dissipation rating can be used to control an SSR or I/O module.

Many TTL gates, for example, will safely dissipate 40mW or more; and the total package will dissipate up to one Watt. (This gate power must not be confused with relay input power.) Whereas an SSR in which the input requires 6mA at 5Vdc consumes 30mW of power, the TTL gate sinking this same 6mA may have a voltage drop of only 0.2 volt, and power consumption of just 1.2 mW!

TTL gates can only sink relay input current, not source it. This is because the sourcing transistor has a pull-up resistance in its collector circuit. Pulling 11mA through this resistance, in this case 130 ohms, would leave insufficient input voltage to operate the relay. For example, an SSR requiring a nominal 5Vdc may not operate on less than 4 volts.

Typically, the drop across the transistor and diode at 11mA would approximate 0.8 volt; and the drop across 130 ohms is 1.4 volt. This 2.2 volt drop would leave only about 1.8 volts for the relay to operate, not enough for relay turn-on.

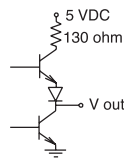

Since TTL gates can only sink current to the relay, and since current sinking is done from a “zero” logic signal, the relay can only be turned on from a “zero” signal. This is contrary to normal relay operation, which prefers that the relay be turned on as a result of a “one” signal. To obtain relay actuation from a logical “one” signal, it is necessary to use an inverting gate. With such a gate, when a “one” signal is received, the sink transistor will turn on and conduct relay input current.

## Changing Pickup and Dropout Voltage

By using a zener diode in series with the input, the pickup and drop out voltage of a Solid State Relay or an I/O Module can be increased by the value of the zener. For example, a typical SSR has a maximum pick up voltage of 4 Vdc and a minimum drop out of 1 Vdc. By adding a 6 volt zener as shown, the new pick up will be 10 volts and the new drop out 7 volts.

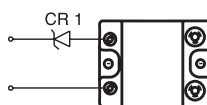

## Latching SSR

An AC SSR can be made to self latch (at the sacrifice of input-output isolation), thus permitting the use of momentary action switches for on/off or stop/start operation. It may be necessary to insert an RC filter across the relay input to prevent the relay from turning on due to switching transients upon application of system power. Note that the SSR employed here must be an AC input type.

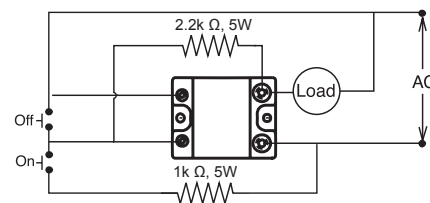

## Installation Density

To achieve maximum installation density and to provide separate wiring channels for the high voltage/high current wires vs the control signal wires, Continental Industries’ RV family of 25 or 40 amp products can be installed as shown below. Please ensure that you observe the wire terminal numbers. The spacing shown is the minimum requirement for most industrial applications. Unrestricted airflow is needed for the Continental Industries product to perform at its rated capacity.

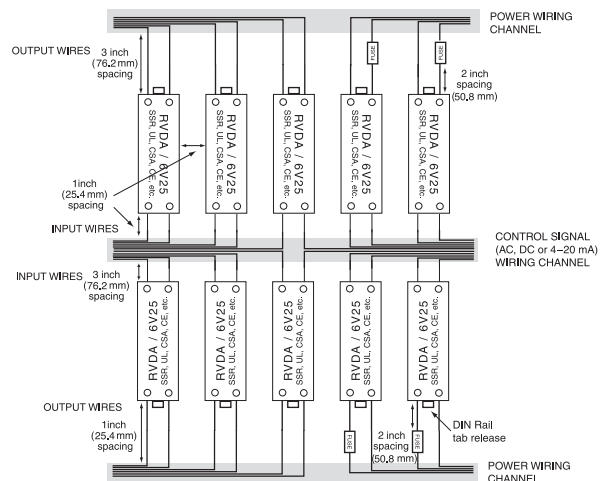

## Crimped-on Wire Terminals

When using either Ring or Spade crimped terminals with the SV or SVDD relays, do not use the saddle clamps that are provided. It is sufficient to secure the Ring or Spade Connectors with the enclosed screws.

When using electrical wire that is larger than #10 AWG with the RVDA, RVAA, or RVMA relays, 25-40 amp models, use a crimped lug, such as Amp# 790368-1 or equivalent.

## DIN Rail Sizes

All DIN Rail mountable relays and modules will fit on any standard 35mm rail.

## Heater Loads

Solid State Relays are well suited for driving heaters, however, in some temperature control applications the load is rapidly and almost continuously switched on and off. This is ideal for purely resistive loads (0.9-1.0 power factor). For loads of power factor 0.8-0.9 CI recommends increasing the controller cycle time to 5 sec. minimum. Loads with a power factor <0.8 should be derated for inductive load.

Recommended Heater Loads:

SSR Rating	at 120Vac	at 240Vac	at 480 Vac
10A	960W	1.9KW	3.8KW
25A	2.4KW	4.8KW	9.6KW
50A	4.8KW	9.6KW	19.2KW
75A	7.2KW	14.4 KW	28.8KW

Low cold resistance elements such as Tungsten or Short Wave Infra Red have special design considerations due to high inrush currents. Please consult the factory.

## Solenoid Valves and Contactors

All of Continental Industries' power SSRs use high noise immunity circuitry in addition to a snubber network to handle the electrical noise generated by inductive loads.

However, the cycling of a solenoid load will generate large current spikes which will decrease the power capability of the SSR. The power rating of the SSR will be reduced by the power rating percentage shown.

Cycle Time	Power Rating
20 sec.	80%
5 sec.	65%
1 sec.	40%

Recommended Solenoid Loads =  $V \times I \times (\text{Power Rating})$

Recommended Solenoid at 5 sec. cycle time.

SSR Rating	at 120Vac	at 240Vac
10A	780W	1.9KW
25A	2.0KW	3.9KW
50A	3.8KW	7.6KW
75A	5.8KW	14KW

## Short Circuit Protection

The relay can be short circuit protected with an appropriate semiconductor fuse. The load integral of the relay ( $I^2t$ ) determines which size of fuse is to be used. The fuse load integral must be below that of the relay for the appropriate protection. Be certain to analyze the fuse current/time curve to insure that the fuse can withstand the motor starting current (if applicable).

NOTE: Overload protection should be provided by another slow-acting fuse in series with the short circuit protection fuse. (An overload being an overcurrent condition that is not of high enough amplitude to be considered a short circuit).

## Transient Voltage Protection

When operating a relay in an electrically noisy environment, large voltage transients may damage the relay. To protect against this occurrence, it is advisable to install appropriate varistors across the respective supply and load terminals of the relay output.

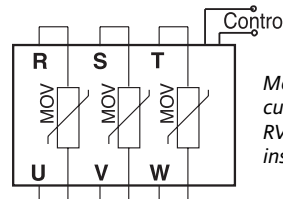

Model RVx3/6V75T/x shown with customer-installed MOVs. Model RVxx/SV series has internal MOVs installed.

If your application is located near inductive loads, or shares power sources with large inductive loads that are creating transients in excess of the blocking voltage of the Continental Industries solid state relay, then you must install a metal oxide varistor (MOV) to protect the solid state relay. **It is up to the installation company to properly size the MOV to the application!** Ideally, the MOV protection is near the noise generating inductive load (such as a motor, drive, or other large inductive coil) or you can place MOVs directly across the output terminals of the SSR. Some "typical" MOVs include:

- 600 volt application - Harris V660 LA80B
- 480 volt application - Harris V575 LA80B
- 300 volt application - Harris V320 LA40B

# Application Notes

The new SV and RV families of solid state relays include the Superior Surge Survival™ technology that dramatically reduces your need to install an external MOV except in extremely noisy environments or inductive load applications.

## Single Phase Motor Control

The following table gives guidelines for selecting relays for single phase non-reversing motors. **Driving reversing motors is not recommended due to the potentially destructive voltage doubling and capacitive discharge that they create.**

Recommended Loads:

SSR Rating	at 120Vac	at 240Vac	at 480Vac
10A	1/4 Hp	1/2 Hp	-
25A	1/3 Hp	1 Hp	2 Hp
50A	3/4 Hp	2 Hp	3 Hp
75A	1-1/4Hp	3 Hp	7-1/2 Hp

## Lamp Test

An AC output solid state relay can be quickly and easily tested. To evaluate whether or not it is operative, connect the relay as follows using the appropriate voltages. The lamp bulb should not turn "On" until the control voltage is applied (and "Off" when control voltage is removed). If the lamp comes "On" with no control voltage, the output is shorted.

Shown is an AC output solid state relay. DC units can be checked the same way with appropriate DC voltages and load.

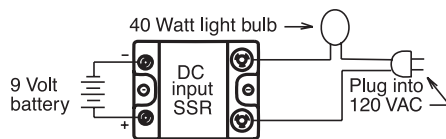

## Safety

Due to their leakage current Solid State Relays are NOT open circuits, even when in the off-state. Safety can only be achieved by a mechanical disconnect between the solid state relay and the power lines.

## DC Output Relay - Transient Protection

Most loads are inductive, even ones that are not so labeled. An inductive load will produce harmful transient voltages when it is turned off. Power MOSFET outputs can be susceptible to the transient voltages produced by seemingly "non-inductive" loads and can be damaged if not properly protected. A protection diode across the load is recommended.

Input and output polarity must be observed. Inductive loads must be diode suppressed.

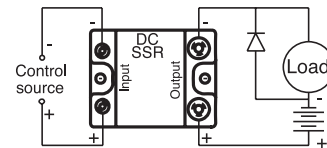

The diode used should be of the fast-recovery type with a reverse voltage rating at least equal to the supply voltage. Examples of fast-recovery diodes that can be used for transient suppression:

RELAY MODEL	MOTOROLA DIODES	GE DIODES
SVDD	MR851	A115A

These diodes are suitable for most applications. For fast repetition rates consult factory for further information.

## Typical Temperature Control Installation

Electrically heated chamber application:

- DC activated RVDA solid state relay
- Thermocouple input
- Alarm for operator warning

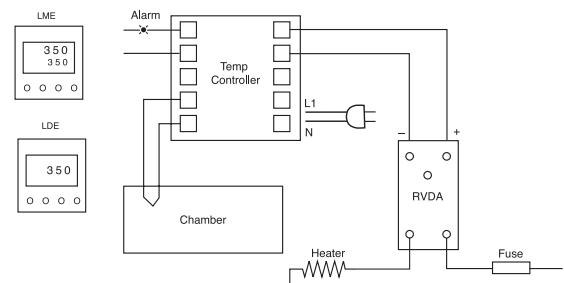

## Typical Temperature Control Application

Packaging or food processing application:

- SVDA solid state relay
- Analog sensor input
- Alarm circuit to stop PLC or related equipment

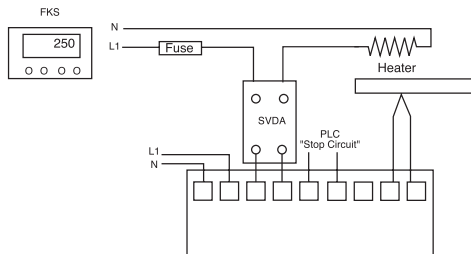

## Locking Screws - RS and RV Units

Screws are prevented from self-loosening by a special design. The automatic progressive locking principle generates an increasing thread friction as the screw is tightened. Repeated tightening and loosening does not cause fatigue of the locking components. Recommended torque is 7-9 in/lbs. Care should be taken not to overtighten screws.

## Fusing Considerations

Circuit Breakers and slow blow fuses offer no protection to Solid state relays. Fast, "I<sup>2</sup>T Semiconductor Fuses" are the only reliable way to protect SSRs.

All solid state relays have an I<sup>2</sup>T rating. This rating is the bench mark for their ability to handle a shorted output condition. Continental Industries advocates circuit protection through the use of a properly selected I<sup>2</sup>T (semiconductor fuse).

Devices such as electromechanical circuit breakers and slow blow fuses cannot react quickly enough to protect the SSR in a shorted condition and are not recommended!!

For fuses, I<sup>2</sup>T is the measure of let-through energy in terms of current versus time. For solid state relays, I<sup>2</sup>T is based directly on the output thyristor's single-cycle peak surge current determined by:

$$I^2T = \frac{I^2_{pk(surge)}}{2} \times 0.0083 \text{ (sec)}$$

The procedure is to select a fuse with an I<sup>2</sup>T let-through rating that is less than the I<sup>2</sup>T capability of the solid state relay for the same duration.

An I<sup>2</sup>T fuse protects the solid state relay. You still need a regular fuse or circuit breaker to protect the complete installation, in accordance with your local electrical code.

## Leakage - Effect on Input

Many temperature controllers and PLC's use triacs as output devices and most manufacturers place a ".022 microfarad snubber" across their triacs for their own protection. This snubber can produce enough leakage when the controller is "off" to cause the solid state relay connected to it to go "on" or at least to not turn "off" properly.

A solution to this problem is to place a 10K ohm, 2 Watt resistor (for 120 Volt control), across the input (control) of the solid state relay.

The SVAA and RVAA family typically do NOT need the additional burden resistor. This saves you installation time and cost.

## Output Leakage

Solid state relays typically have 8mA leakage current, even in their off-state. The only safe way to prevent shock is to have a mechanical disconnect between the line and the relay.

## Direct Copper Bonding

Continental Industries employs the proven reliability of direct copper bonding technology to all of its SCR chip assemblies. This direct bonding provides a more reliable mechanical connection between the SCR and the heat sink, by reducing the physical stress on the chips and also provides for better heat dissipation by reducing the layers heat must travel through to the ambient. This results in a more durable relay and a longer usable relay lifetime.

## Using SSRs with Electromechanical Relays

Using an SV or RV relay to activate an electromechanical or mercury contactor is possible. Electromechanical relays produce a significant amount of electrical noise which could cause a solid state relay to mistrigger. If these two types of relays are used together, surge voltage protection may be required.

# Application Notes

---

---

## Caution

Continental Industries International's Solid State Relays, Input/Output Modules, controls, and other Continental automation products can (as is possible with any electronic component) fail without warning. For this reason Continental Industries International cannot recommend, condone or warrant any application of our products that could cause harm or injury, in any manner, to any person, equipment, or facility upon such failure of the product.

For your safety and to protect the equipment from damage in the event of failure, it might be necessary to insert some type of upper-limit device (e.g. thermal) in series with the relay output to cause discontinuance of current to the load. Additionally, it is advisable to have a mechanical disconnect in the load circuit for service purposes.

Caution: the heat sinks shown in this catalog are capable of being over 100°C (212°F) when they are operating correctly in an installation. This could cause burns. ALWAYS completely

de-energize an SSR and let it cool down before touching the unit. All heat sinks must be installed on a vertical metal surface with unrestricted airflow that flows up, through the fins, and out the top of the heat sink. Mounting the heat sinks on a horizontal surface, or limiting airflow due to other components being installed nearby, will severely decrease the ability of the heat sink to perform as specified.

Always disconnect the electrical power before touching the SSR or the load. Otherwise, an electrical shock hazard may exist. Failure to do this may result in electrocution or death.

Continental Industries International's products are intended for use where access is limited to qualified service personnel. Continental Industries International's products are not intended for use in explosive atmospheres.

CE installation category is Class 3 or lower.

Please contact the factory if you have any doubts or questions as to whether this caution applies to your application.